



**Building
Products**

Precast Concrete



BCP Building Products

18 Kirkcaldy Street Bathurst NSW 2795

Phone 02 6331 2777

Fax 02 6331 6510

sales@bcpbuildingproducts.com.au

www.bcpbuildingproducts.com.au

Precast

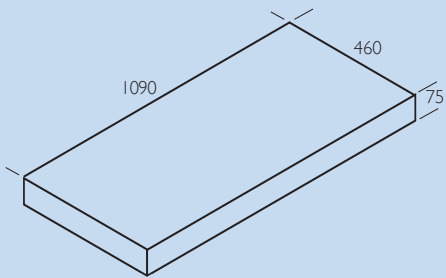

Flat Step Treads

Sizes	Weights
I-090	84kg
I-200	96.2kg
I-350	109.2kg
I-500	121.6kg
I-650	134kg
I-800	146.4kg

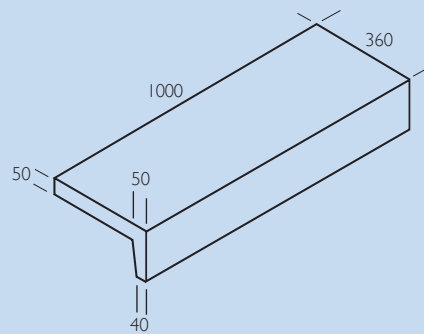

Step Treads with Risers

Sizes	Weights
900mm	49kg
1000mm	54kg
1200mm	65kg
1500mm	78kg
1800mm	95kg

Garden Accessories

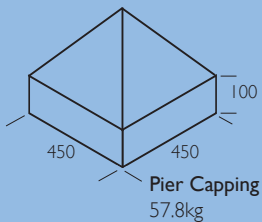

Pier Capping
57.8kg

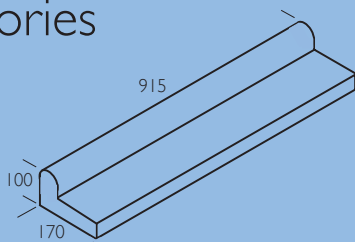

Garden Edge
25kg

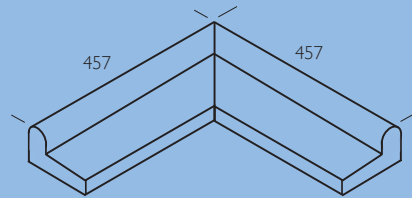

Garden Edge Corner Internal 17.5kg
External 18.1kg

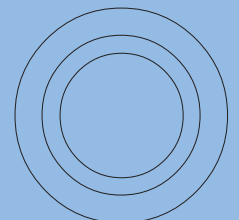

Tree Surround
Large Full 450mm internal dia
Half Split 450mm internal dia
Small Full 300mm internal dia

Spoon Drain

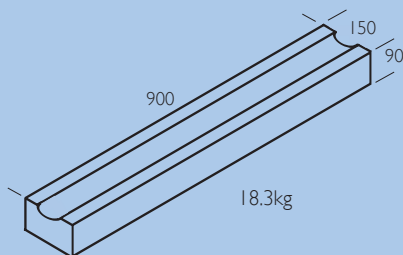

18.3kg

Reinforced Slabs

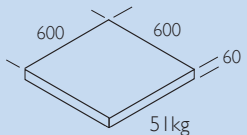

51kg

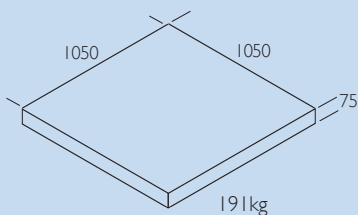

191kg

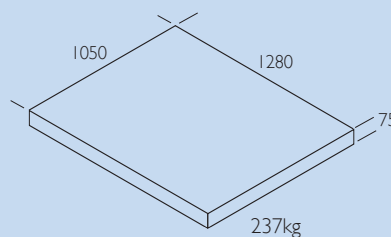

237kg

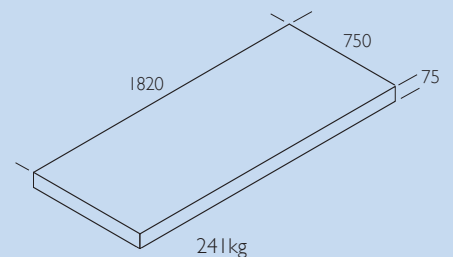

241kg