







Esplanade Charcoal

Timeless. Classic.



Patios



Courtyards



Outdoor Living



Paths



Stepping Stones



Stairs

Suitable for pedestrian traffic only. Not suitable for salt water pool surrounds.

From Patios to pathways, the Esplanade® range of pavers is the perfect choice. This square format paver with bevelled edges and spacer nibs on 3 sides for even spacing and easy laying, is a simple and timeless paving system for all projects large and small.

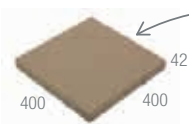

One side has no spacer nibs so you can easily & economically make step treads with a smooth leading edge.

**Esplanade®**  
**400 Standard**  
Units per m<sup>2</sup>: 6.25



Charcoal

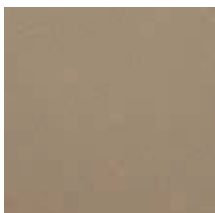

Ginger



Sand

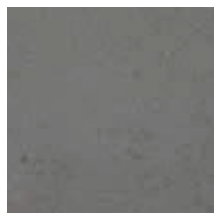

Platinum



Esplanade Ginger



Drivepave Charcoal with Drivepave Sand header & Modernstone Light Sands retaining wall

## Driving durability



Patios



Courtyards



Outdoor Living



Paths



Driveways  
(Residential)

Use our economical Edgepave® (see next page) for garden edging and mower strips.

Drivepave's clever spacer lugs, incredibly accurate face dimensions and finely finished, deep bevels, represent the pinnacle of design for contemporary, stylish and durable driveways.

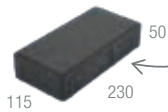

Drivepave®  
Units per m<sup>2</sup>: 37

Spacer nibs prevent pavers chipping when butted up too tightly in areas subjected to vehicle or pedestrian traffic and ground movement. All pavers should be laid with at least 2-3mm joints between them, filled with jointing sand.

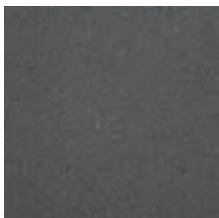

Charcoal

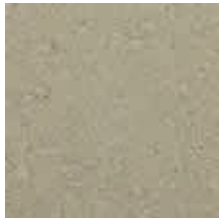

Sand



Drivepave Charcoal



Edgepave Charcoal

## Defining edge gardens



Paths



Garden Edging



Mower Strip

Lay Edgepave® units side by side into 50mm thick dry or wet concrete mix to make a deeper, wider barrier between garden bed and lawn.

The streamlined design of Edgepave® is intended specifically for stylish and economical garden edging. We recommend our Drivepave (see previous page) with its slightly larger dimensions and smart spacer nibs for extensive pavements like driveways and courtyards.



Edgepave®  
Units per m<sup>2</sup>: 50

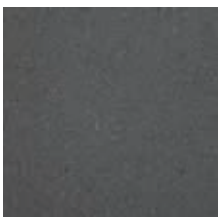

Charcoal

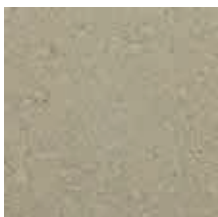

Sand



Edgepave Charcoal



Interpave Charcoal

Withstand heavy loading



Roadways



Heavy Vehicle



Container Terminals



Airports



Domestic Driveways



Car Parks

Lay in the Herringbone Pattern for maximum interlock and pavement strength.

Interlocking segmental paving systems are engineered for high volume traffic and able to withstand heavy loading.



**Interpave® IP80**  
Units per m<sup>2</sup>: 40



**Streetpave SP80**  
Units per m<sup>2</sup>: 40

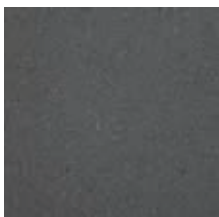

Charcoal



Natural



Interpave Charcoal with Interpave Natural detail



Interpave Charcoal

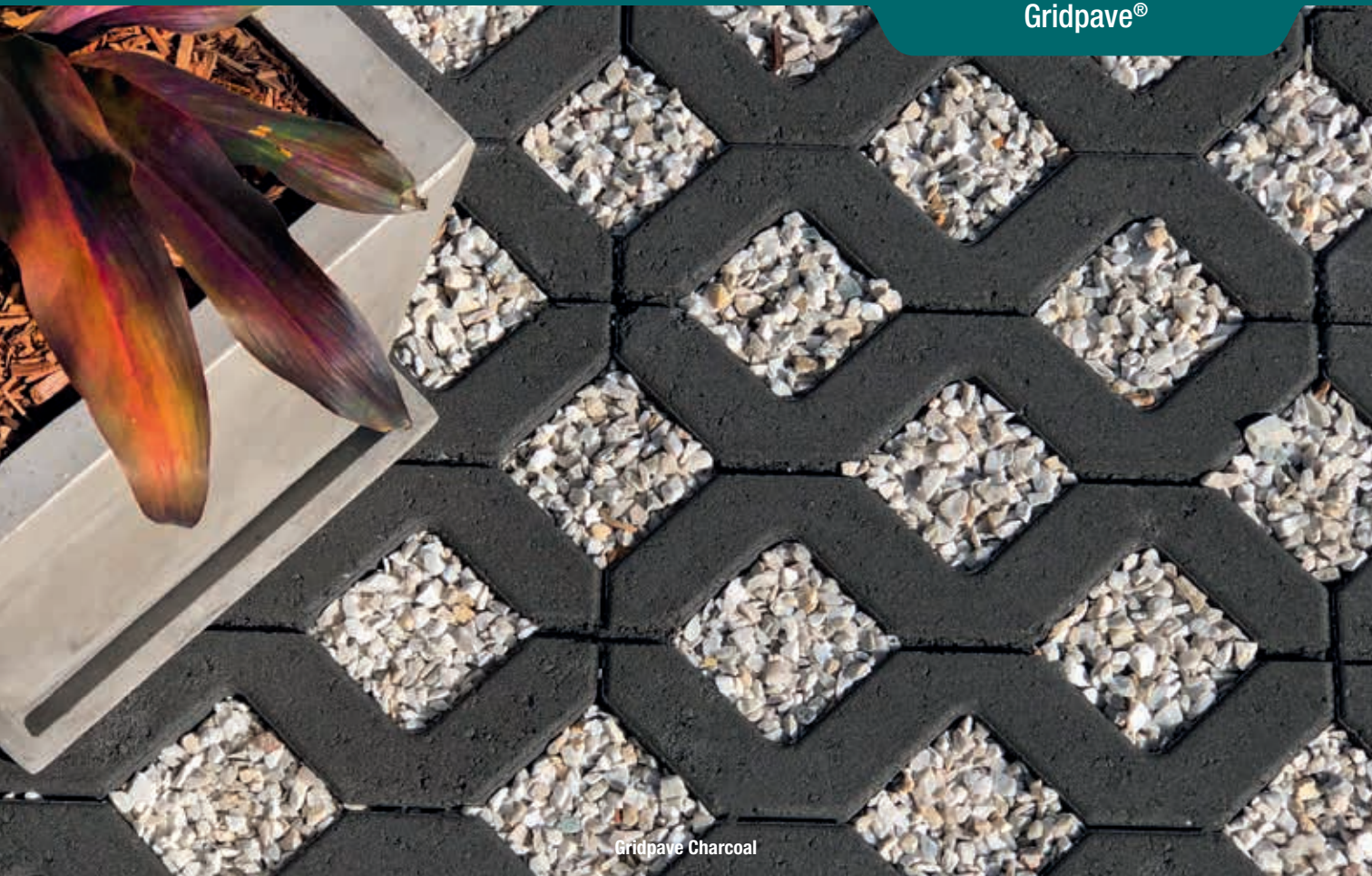

Gridpave Charcoal

Drainage & grass friendly



Dam Embankments/  
Livestock



Boat/Caravan  
Parking



Car Parks



Driveways

Versatile and dynamic Gridpave combines equally well with either turf, drainage gravel or decorative gravel.

From erosion control to water management and drainage, National Masonry's Gridpave® is your one paver solution. Gridpave reduces rainwater run off and protects sloping areas from rutting or eroding while adding greenery, interest and style.

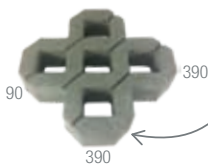

Gridpave®

Units per m²: 6.57

New improved version with spacer nibs for ease of laying and accurate 2-3mm joint width.

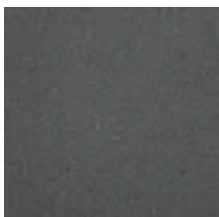

Charcoal



Natural



Gridpave Natural

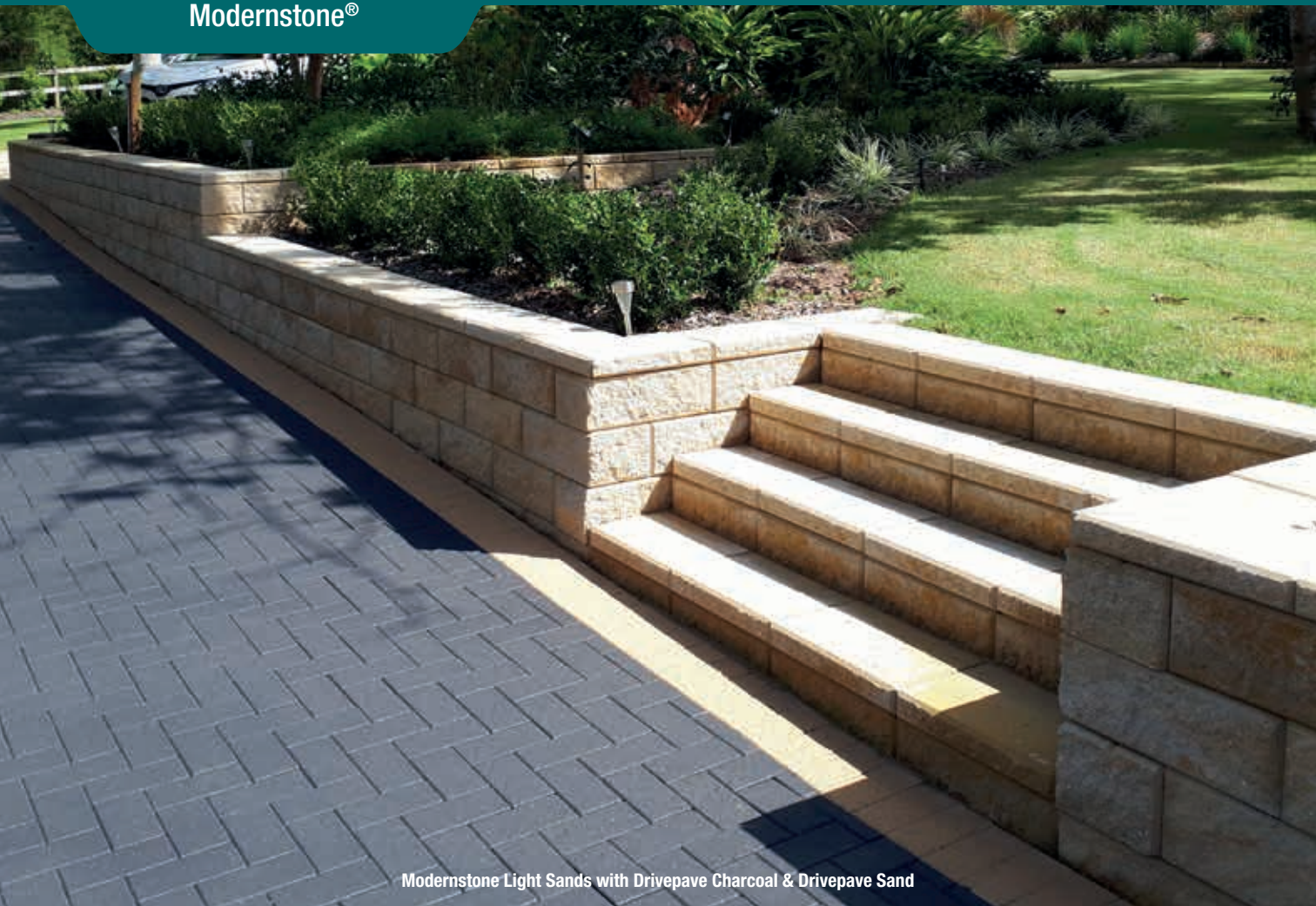

Modernstone Light Sands with Drivepave Charcoal & Drivepave Sand



Modernstone Charcoal





Modernstone Charcoal

Contemporary and classic



Curved Wall



Straight Wall



Garden Beds



Stairs



Corner Wall



Tiered Walls

Maximum Unreinforced Wall Height: 990mm + cap - see Retaining Wall Installation p.20-21 for details.

Modernstone® is our flagship retaining wall system. Long and sleek with a sharp picture framed split face finish, Modernstone® versatile appeal complements the cutting edge architectural designs through to the contemporary and the classic.



**Modernstone® Standard**  
Max Wall Height: 1050mm  
Units per m²: 13.77



**Modernstone® Corner**  
Max Wall Height: 1050mm

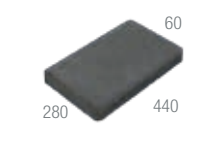

**Classic Cap**  
Units per l/m: 2.27

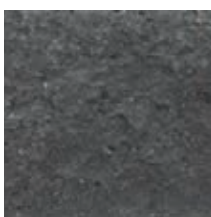

Charcoal



Light Sands



Beach

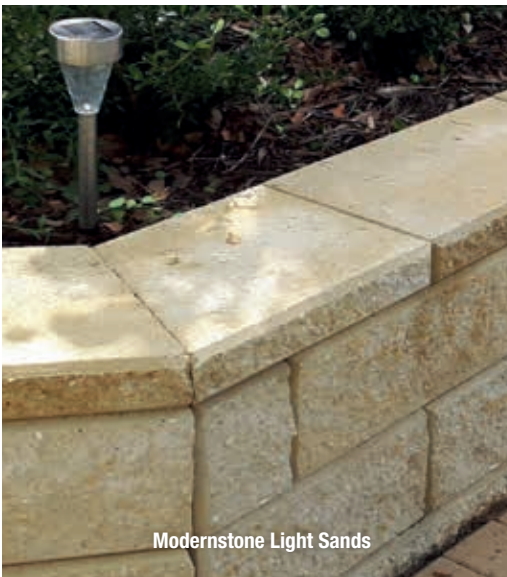

Modernstone Light Sands



Modernstone Beach





Gardenwall Standard Charcoal

Simple and quick installation



Curved Wall



Straight Wall



Garden Beds



Garden Edging



Fire Pits



Tiered Walls

Maximum Unreinforced Wall Height: 1000mm - see Retaining Wall Installation p.20-21 for details.

Gardenwall® is the number one “Link” block system on the market and is exclusively manufactured by National Masonry®. This versatile single block system is the DIY dream where one block does it all. Gardenwall Standard blocks are hollowed out underneath to make them easier to handle.



Gardenwall® Standard

Max Wall Height: 1000mm  
Units per m<sup>2</sup>: 26.9



Charcoal



Beach



Light Sands



Gardenwall Standard Light Sands

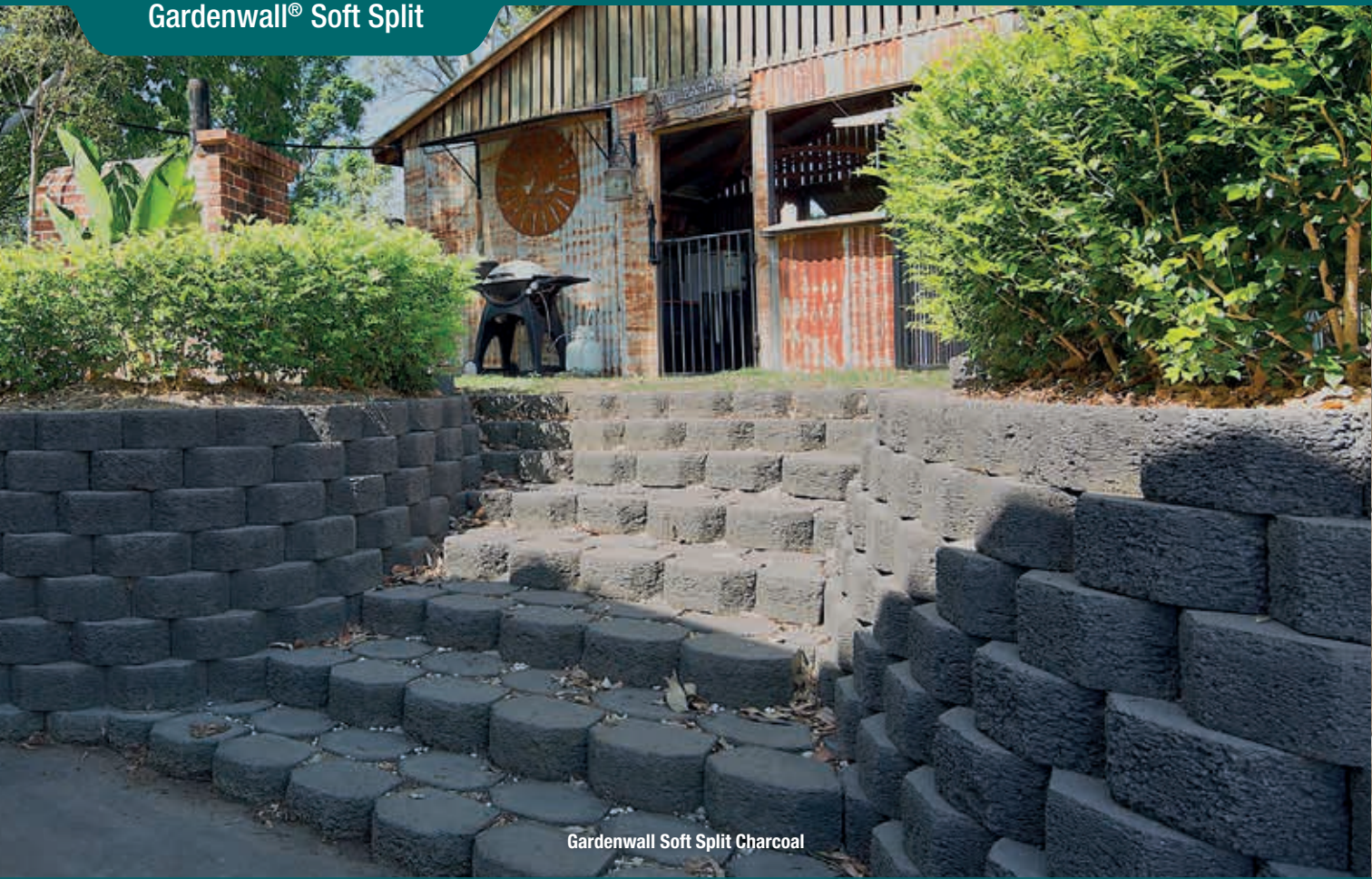

Gardenwall Soft Split Charcoal

Simple and quick installation



Curved Wall



Straight Wall



Garden Beds



Garden Edging



Fire Pits



Tiered Walls

Maximum Unreinforced Wall Height: 1000mm - see Retaining Wall Installation p.20-21 for details.

Gardenwall® is the number one “Link” block system on the market and is exclusively manufactured by National Masonry®. This versatile single block system is the DIY dream where one block does it all. Gardenwall Soft Split blocks are totally solid for extra weight and retaining strength.



**Gardenwall®**  
**Soft Split**  
 Max Wall Height: 1000mm  
 Units per m²: 26.9



Charcoal

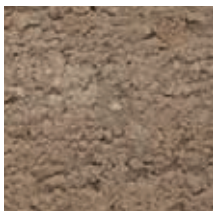

Paperbark

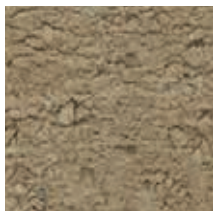

Portstone



Coco



Gardenwall Soft Split Paperbark



Gardenwall Soft Split Portstone



Gardenwall Flushface Beach

Simple and quick installation



Curved Wall



Straight Wall



Garden Beds



Garden Edging



Fire Pits



Tiered Walls

Maximum Unreinforced Wall Height: 1000mm - see Retaining Wall Installation p.20-21 for details.

Gardenwall® Flushface is an adaptation of our Gardenwall Standard. The face is split in a straight line for a more modern look while still enjoying the extra engineered retaining strength of the 25mm setback per course. Gardenwall Flushface is hollowed out underneath for easier handling. Perfect for straight or slightly curved walls. For tighter curves, use Gardenwall Standard.



Gardenwall®  
Flushface

Max Wall Height: 1000mm  
Units per m²: 26.9

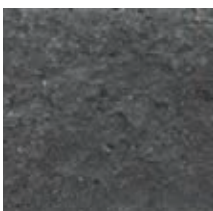

Charcoal



Light Sands

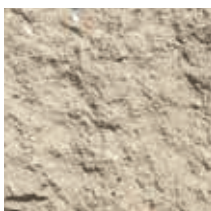

Beach



Gardenwall Flushface Charcoal





Linearwall Beach with Esplanade Sand pavers

Easy, true vertical walls with no need for caps



Corner Wall



Straight Wall



Garden Beds



Garden Edging



Fire Pits



Tiered Walls

Maximum Unreinforced Wall Height: 600mm - see Retaining Wall Installation p.20-21 for details.

Linearwall® with its bevelled straight split face finish and clever design makes building sleek contemporary walls child's play.



**Linearwall®  
Standard Unit**  
Max Wall Height 600mm

Units per m<sup>2</sup>: 22.2



**Linearwall®  
Right Corner**



**Linearwall®  
Left Beach**



Charcoal



Fudge



Beach



Linearwall Fudge with Stoneworks Aspenstone Vanilla



WedgeBLOK™

WedgeBLOK™ - The Wedgie Gardeners Want



Paths



Garden Edging



Mower Strip



Curved Wall



Straight Wall



Garden Beds



Garden Edging



Fire Pits

Maximum Unreinforced Wall Height: 500mm = 4 courses. No surcharge loads.

WedgeBLOK™ is the perfect size and shape for creative garden edging. Easy to handle, double chamfered face (small and large face on every block), lay them straight or curved with no gaps, tree circles, fire pits (with a fire bowl inserted), small decorative walls (use an outdoor concrete adhesive to secure each course). Best of all: the smooth faces are gentler on whipper snippers for easier garden maintenance!



WedgeBLOK™  
Max Wall Height: 500mm

Units per lin m: 7.14 (butt jointed) or 6.25 (gapped)

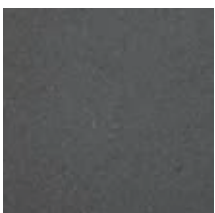

Charcoal

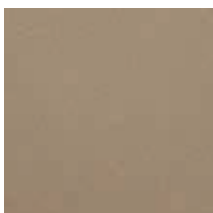

Ginger



Sand

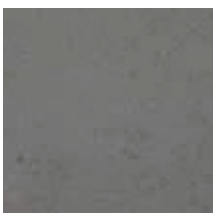

Platinum



WedgeBLOK Charcoal



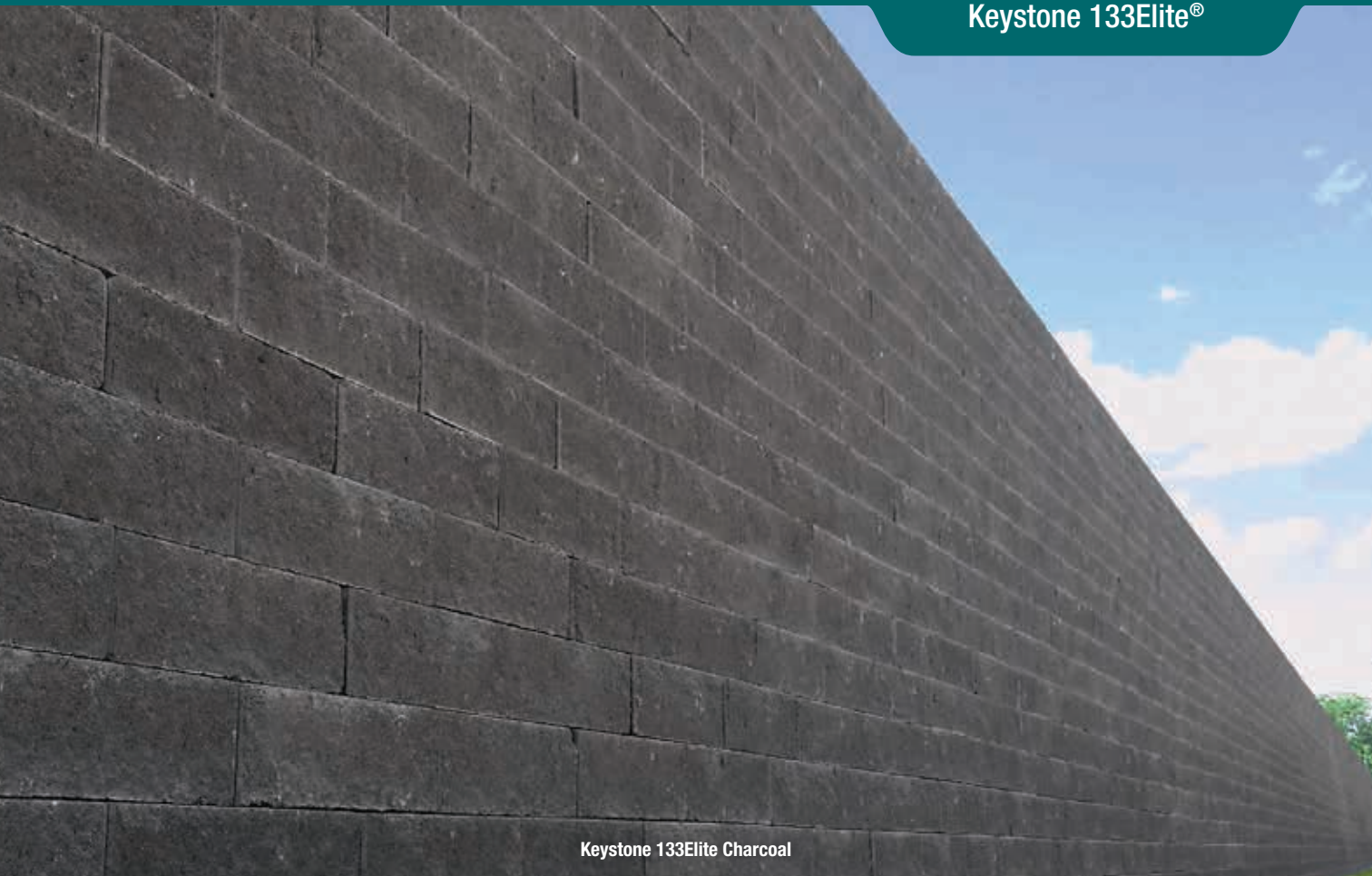

Keystone 133Elite Charcoal

Engineered Solutions



Curved Wall



Straight Wall

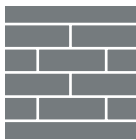

Gravity & No Fines Walls



Geogrid Soil Reinforced Walls



Embankment Stabilisation



Tiered Walls

Maximum Unreinforced Wall Height: 1,000mm + cap - see p20-21 for details.

The Keystone 133Elite® is the professional's choice for larger soil reinforced retaining wall applications. With its unique interlocking pin system, the Keystone 133Elite® is a strong and secure wall system that accommodates a large range of applications.

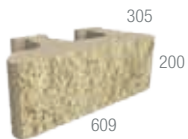

Keystone 133Elite® Standard Unit

Max Wall Height 10000mm+  
Units per m2: 8.3

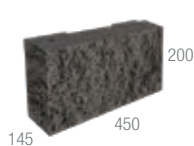

Keystone 133Elite® Corner Unit

Units per l/m: 1.64



Keystone 133Elite® Cap

Units per l/m: 1.64



Charcoal



Parchment



Keystone 133Elite Parchment



## Excavation and Base

Excavate the area to be paved to allow for the base layer (generally 100 -150mm thick of road base), bedding sand (generally 30mm thick coarse washed river sand) and the paver thickness. Establish falls and level using a spirit level on the screed board. Spread the road base to an even thickness and compact using a mechanical plate compactor. The finished pavement surface is only as level as the base layer, so make sure any high and low spots are leveled out to provide a flat, well compacted finish. Do NOT use crusher/cracker dust as your base layer as it does not provide the same interlocking strength as a well graded Road Base.



## Prepare the Bedding Sand

Place 2 screed rails parallel to each other and around a metre apart on top of the compacted and levelled road base. Screed rails should be about 30mm thick - PVC piping works well. Fill in between and on either side of the rails with a coarse, washed, bedding sand to a little over 30mm thick, just above the level of the rails. Do NOT use crusher/cracker dust as a bedding layer as it contains minerals that can cause serious staining in the long term. Crusher dust also does not drain as well as coarse washed bedding sand, and may increase the risk and severity of efflorescence.



## Screed the Bedding Sand

With a Concreter's Screed or similar, scrape excess sand toward you over the top of the rails. With large jobs it may be easier to have one person on each end of the screed rail. Carefully remove the screed rails (or slide them down to the next section), filling the voids with more coarse, washed bedding sand and leveling with a Wooden Float or Trowel. The bedding sand should be very flat and level.



## Set the Lines

Carefully plan where your full pavers will go, and where any cuts will be required. Minimise the number of cuts and try to put them in less conspicuous places. Use string lines to ensure your pavers will be laid in a straight line and right angles are established.



## Begin the Laying

Start laying along the longest straight edge of the designated area. Ensure an even 2-5mm gap is left between each paver to avoid chipping. Pavers with spacer nibs (Esplanade, Gridpave, Drivepave and Interpave) make this easy. Be careful not to disturb the bedding sand when laying your pavers - minimize foot traffic on freshly laid pavers until after final compaction. Regularly stand back a few metres and check visually for any unwanted curvature or "wobbles" before it's too late to fix them.



## Edge Restraints & Cuts

Edge restraints can be installed before or after you start laying pavers. They should provide a permanent, strong edge to keep the pavers from spreading out and stop sand from washing away. A poured concrete haunch that keys into the base layer is a good option, but anything from purpose made aluminium edging to an existing brick wall can be used. Carefully cut pavers where required with a masonry saw or angle grinder and place carefully in the gaps.



## Fill the Joints

Sweep a fine, clean, jointing sand over the finished paving. Dry sand fills the joints faster and more evenly. Do not use sand that contains clay. Polymeric sands (which contain an additive to bind the sand) can be used to create a flexible joint that resists ants, weeds and wash outs. Cement is not recommended in joints as it can cause permanent staining if mishandled and can crack if the pavement flexes.



## Compacting Pavers

While the jointing sand is still on the surface, run a light vibrating plate, with protective carpet attached to the base of the plate, over the top of the pavers. It will compact the bedding sand under the pavers and vibrate the jointing sand into the joints, locking the pavement firmly into position. Sweep any remaining sand off the surface. Vibrating plates may break some pavers, replace as necessary with your spare pavers. We always recommend purchasing up to 5% extra to allow for this or wastage in cutting and handling.

## Prevention is better than cure

- Sweep regularly with a stiff bristled broom to keep pavers free from debris.
- For maximum protection we suggest pavers are sealed after installation with a penetrating sealer. Please check with a reputable sealing company for advice.
- Seal pavers with a penetrating sealer before grouting to avoid grout smears.
- Re-seal pavers as required paying extra attention to heavy wear areas and salt-water locations.
- During construction, cover the paved areas to protect against damage.
- Protect your pavers against possible staining from mortar, oxides, cement and rust.
- Do not use high pressure cleaning apparatus to clean pavers.
- In all cases, attempt to clean a stain before it hardens or dries.
- Assess type of stain carefully before taking action (incorrect assessment of stain can cause the stain to be more difficult to remove).
- If stain cannot be accurately assessed, conduct a trial process on a small portion of stained area to determine most appropriate action.
- Do not use hydrochloric acid to remove stains under any circumstances. Refer to the guide beside for some stain removal solutions.

## Sealing

National Masonry® recommends that all pavers should be sealed with a quality penetrating sealer following installation. Please check with a qualified tradesperson for advice on this process. National Masonry® does not accept liability for stained or damaged pavers.

This is general information and should be viewed as a guide only. National Masonry® recommends you obtain professional building advice on your specific paving project.

PROBLEM	SUGGESTED CLEANING METHOD
Efflorescence* (White powdery deposit)	Use Environex Anti-EFF or equivalent as per manufacturers recommendation.
Leaves, bark, algae, food and wine stains	Use Environex Maestro or equivalent as per manufacturer's instructions. Chlorinated cleaners designed for cleaning masonry will remove most organic stains without harming the masonry units. Avoid cleaners containing acid unless absolutely necessary as it is likely they will strip the surface to some degree. Seek professional, job specific advice and always test an inconspicuous area first.

\* Efflorescence occurs naturally in cement based products.

## Edgepave™

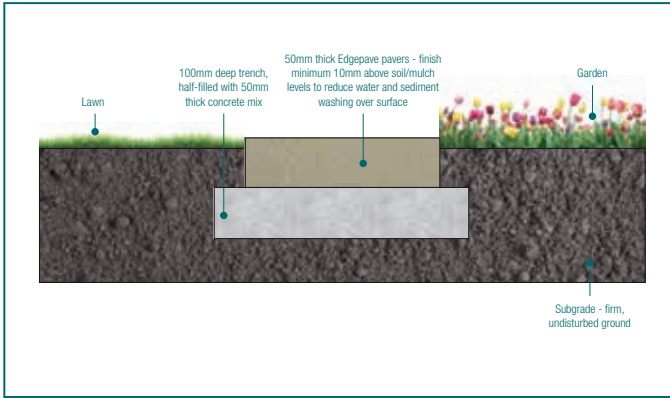

## Esplanade®

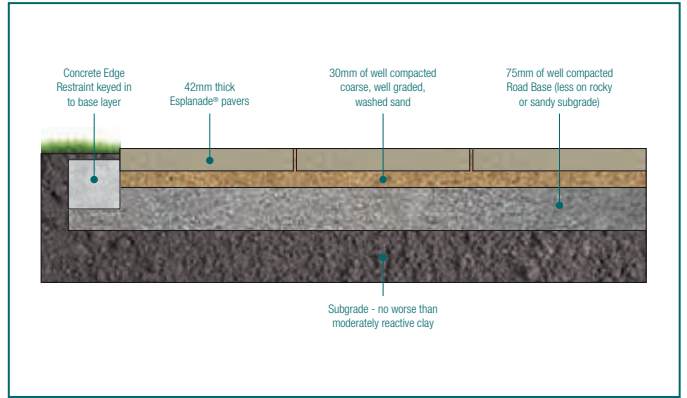

## Drivepave™

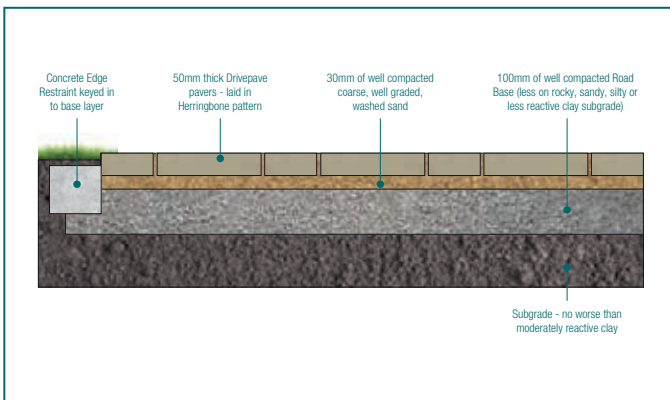

## Interpave®

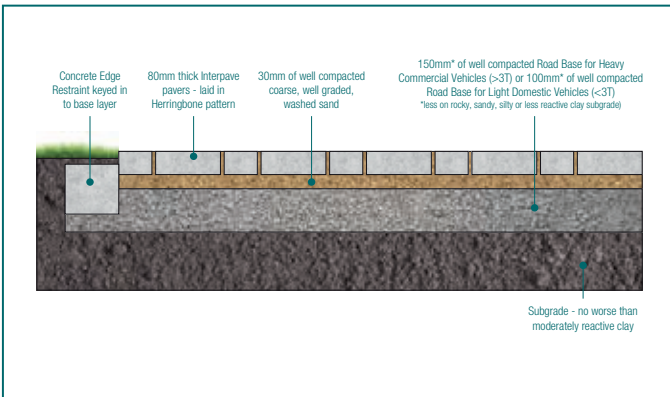

## Gridpave™

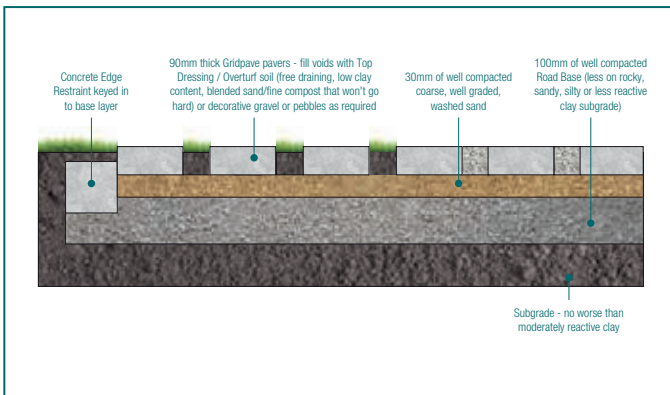



## Locate your wall

Mark out the ground where your wall will be located (either by marking with stakes and a string line or by marking a line on the ground with spray paint). Excavate trench then compact roadbase into trench to form a levelling pad.



## Prepare the site

Place blocks side by side on the levelling pad using a string line along the back of the units for alignment. Level each unit side to side and front to back using your spirit level. Spend time making sure the first course of units is level, otherwise all ensuing courses and ultimately the entire wall will not be level.



## Backfill and compact

Install an agricultural drain 100mm diameter behind your first course and surround with gravel (20-40mm sized gravel, e.g. blue metal). Shovel and compact your backfill (existing site soil) behind the drainage material. (Backfill consisting of heavy clays or organic soils is not recommended due to water holding properties).



## Additional courses

Sweep the top of the previous course clean. Place the next course of units in a running bond pattern (i.e. with the vertical joints from the first course units halfway across the second course units). Pull each unit forward until it locks with the nib on the unit below. Place the drainage material behind the second course of units. Stack units, placing drainage material and compact backfill for each block height layer until your wall is complete.



## Fixing capping units

To remove the lug from the top of Modernstone Blocks before laying caps, place blocks face down (on a soft sand bed or similar, to avoid damage or stains to the face) and knock the lug off with a 4" brick bolster and club hammer using small taps - controlled but increasingly firm - along the length of the lug. Tidy up any dags with the bolster or a 4" grinder. This should all take no more than 30 seconds per block. Lay caps using stringlines on a masonry adhesive that is suitable for outdoor use.

## Modernstone™ - Gravity Wall Cross Section

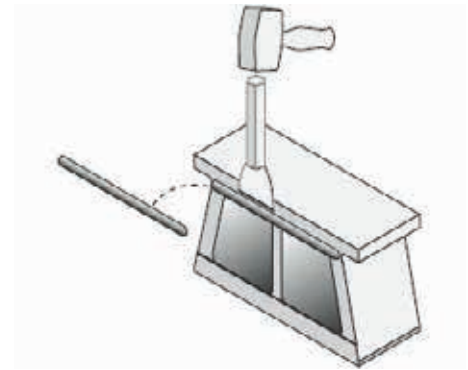
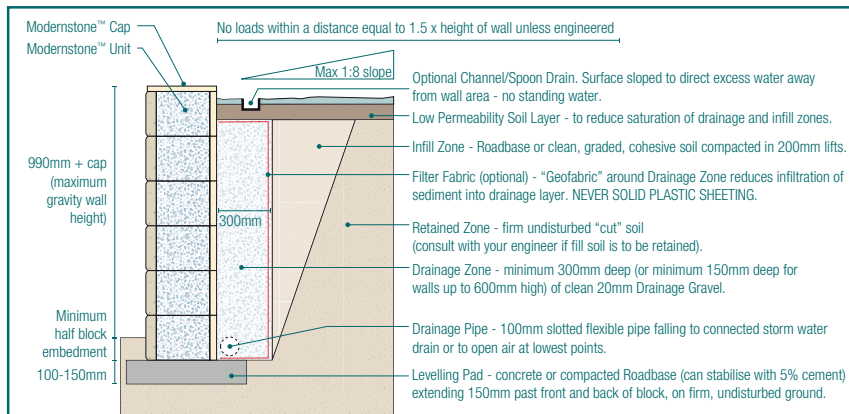

Removing Lug from Modernstone Blocks before Installing Caps.

## Modernstone™ - No Fines Concrete Cross Section

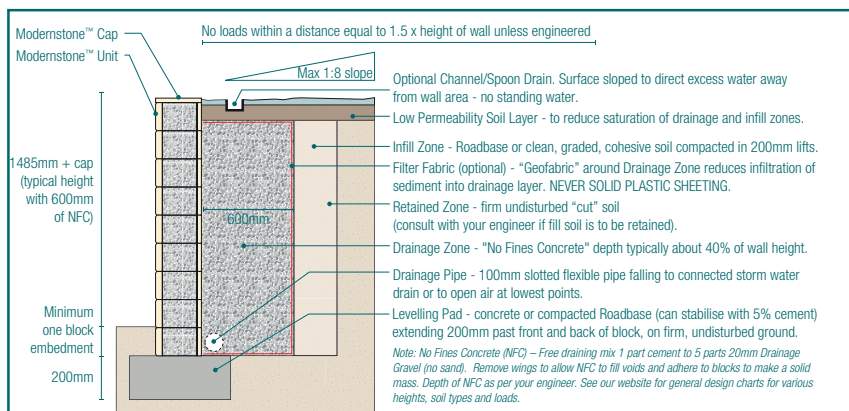

Close up of Light Sands 2-tone colour blending. Some blocks will be mostly yellow or mostly white, others will be randomly blended with both colours.



## Gardenwall® - Gravity Wall Cross Section

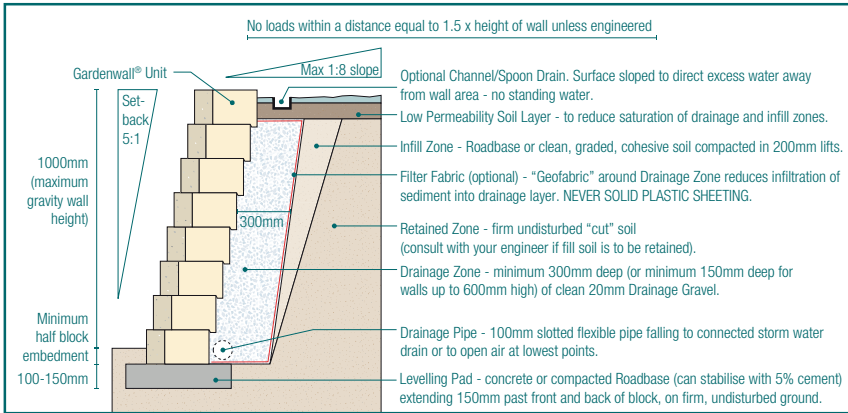

## Linearwall™ - Gravity Wall Cross Section

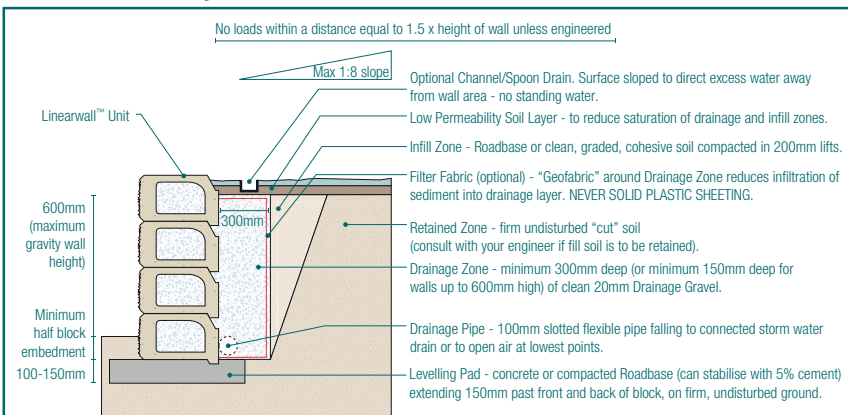



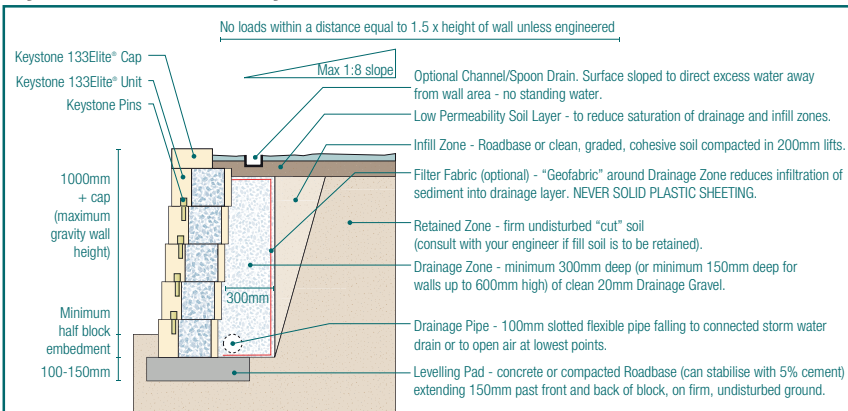

## Keystone 133Elite® - Gravity Wall Cross Section

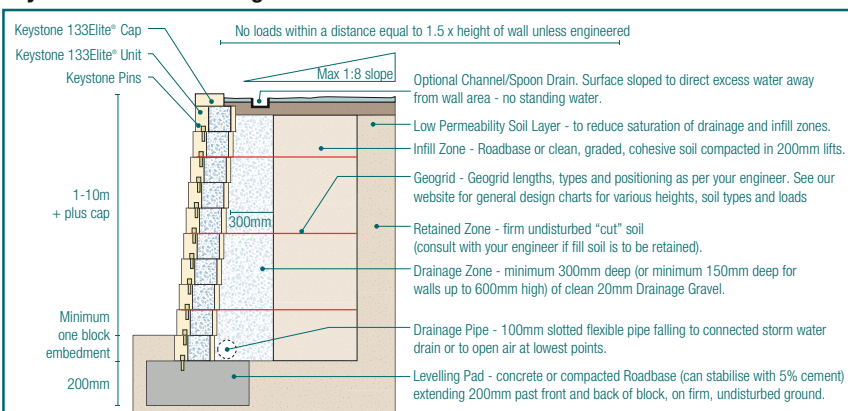



## Keystone 133Elite® - Geogrid Cross Section



## Pavers

Image	Product Name	Dimensions (mm)	Available Colours	Where to use	Weight per unit (kg)	Units per m <sup>2</sup>	Units per pallet
	Gridpave™	390x390x90	Natural, Charcoal	Car Parks, Driveways	17.04	6.57	90
	Interpave®	225x112x80	Natural, Charcoal	Roadways, Heavy Vehicle, Container Terminals, Airports, Ports, Car Parks, Driveways	4.25	40	380 with halves 368 without halves
	Esplanade™ 400 Standard	400x400x42	Charcoal, Ginger, Sand, Platinum	Patios, Courtyards, Outdoor Living, Paths, Stepping Stones, Stairs	13.6	6.25	108
	Drivepave™	230x115x50	Charcoal, Sand	With spacer nibs for Driveways (Residential), Patios, Courtyards, Paths	3.0	37	500



## Garden Edging

Image	Product Name	Dimensions (mm)	Available Colours	Where to use	Weight per unit (kg)	Units per m <sup>2</sup>	Units per pallet
	WedgeBLOK™	160/120x140x125	Charcoal, Ginger, Sand, Platinum	Garden Edging, Mower Strips, Garden Beds, Fire Pits (min 980mm outer / 700mm inner diameter), Small Walls, 500mm (4 courses)	5.0	7.14	336
	Edgepave™	200x100x50	Charcoal, Sand	Without spacer nibs for Garden Edging, Mower Strips, Paths	2.1	50	660

## Retaining Walls

Image	Product Name	Dimensions (mm)	Available Colours	Where to use	Weight per unit (kg)	Units per m <sup>2</sup>	Units per pallet
	Gardenwall® Standard	295x203x125	Charcoal, Light Sands, Beach		11.45	26.9	120
	Gardenwall® Flushface	295x203x125	Charcoal, Light Sands, Beach	Curved Walls, Straight Walls, Garden Beds, Garden Edging, Fire Pits 1000mm (8 courses)	12.65	26.9	120
	Gardenwall® Soft Split	295x210x125	Charcoal, Coco, Paperbark, Portstone		14.2	26.9	100

Retaining Walls continued

Image	Product Name	Dimensions (mm)	Available Colours	Where to use	Weight per unit (kg)	Units per m <sup>2</sup>	Units per pallet
	Modernstone™ Standard	440x280x165	Charcoal, Light Sands, Beach		26.5	13.77	40
	Modernstone™ Corner Unit	440x220x165	Charcoal, Light Sands, Beach	Curved Walls, Straight Walls, Planter Boxes, Benches and Seats, Stairs, Courtyards, Piers & Entrances  1050mm (6 courses + cap)	20	n/a	48
	Modernstone™ Classic Cap	440x280x60	Charcoal, Light Sands, Beach		16.5	2.27 l/m	100
	Linearwall™ Standard Unit	300x200x150	Charcoal, Fudge, Beach		13.25	22.20	90
	Linearwall™ Right Corner	350x200x150	Charcoal, Fudge, Beach	Straight Walls, Corners, Planter Boxes, Benches & Seats, Stairs  600mm (4 courses)	22.2	n/a	60
	Linearwall™ Left Corner	350x200x150	Charcoal, Fudge, Beach		22.2	n/a	60
	Keystone 133Elite® Standard Unit	609x305x200	Charcoal, Parchment		46.0	8.3	40
	Keystone 133Elite® Capping Unit	609x205x100	Charcoal, Parchment	Curved Walls, Straight Walls, Domestic or Commercial 1.1m (5 courses + cap) Gravity Walls 2.1m (10 courses + cap) No Fines Concrete 1m-10m+ (5+ courses) Geogrid Walls	26.5	1.64 l/m	72
	Keystone 133Elite® Corner Unit	450x145x200	Charcoal, Parchment		25.6	n/a	36



All pallets remain the property of National Masonry®

Online Booking Pickup

Call to Arrange Pickup

Use our Pallet Collection Form on our website.

Call your local branch during office hours.

[www.nationalmasonry.com.au](http://www.nationalmasonry.com.au)

1800 066 089

To find your closest National Masonry® stockist, to receive brochures or to learn more about our products, call us or visit our website at [www.nationalmasonry.com.au](http://www.nationalmasonry.com.au)

For even more premium paver options ask for our Stoneworks brochure and visit our website at [www.stoneworkspavers.com.au](http://www.stoneworkspavers.com.au)

**South Queensland**

62 Industrial Avenue,  
Wacol  
Brisbane QLD 4076  
Phone: (07) 3271 9292  
Fax: (07) 3271 1815

[brisbane.sales@nationalmasonry.com.au](mailto:brisbane.sales@nationalmasonry.com.au)

**Gold Coast**

663 Pine Ridge Road,  
Biggera Waters  
Gold Coast QLD 4216  
Phone: (07) 5552 3300  
Fax: (07) 5552 3399

[labrador.sales@nationalmasonry.com.au](mailto:labrador.sales@nationalmasonry.com.au)

**North Queensland**

6 David Muir Street,  
Slade Point  
Mackay QLD 4740  
Phone: (07) 4955 1155  
Fax: (07) 4955 4130

[mackay@nationalmasonry.com.au](mailto:mackay@nationalmasonry.com.au)

**New South Wales**

65 Burleigh Street,  
Toronto  
Lake Macquarie NSW 2283  
Phone: (02) 4088 1888  
Fax: (02) 4088 1899

[toronto.sales@nationalmasonry.com.au](mailto:toronto.sales@nationalmasonry.com.au)

**Victoria**

Riding Boundary Road,  
Deer Park  
Melbourne VIC 3023  
Phone: (03) 9361 6400  
Fax: (03) 9363 6008

[melbourne.sales@nationalmasonry.com.au](mailto:melbourne.sales@nationalmasonry.com.au)